

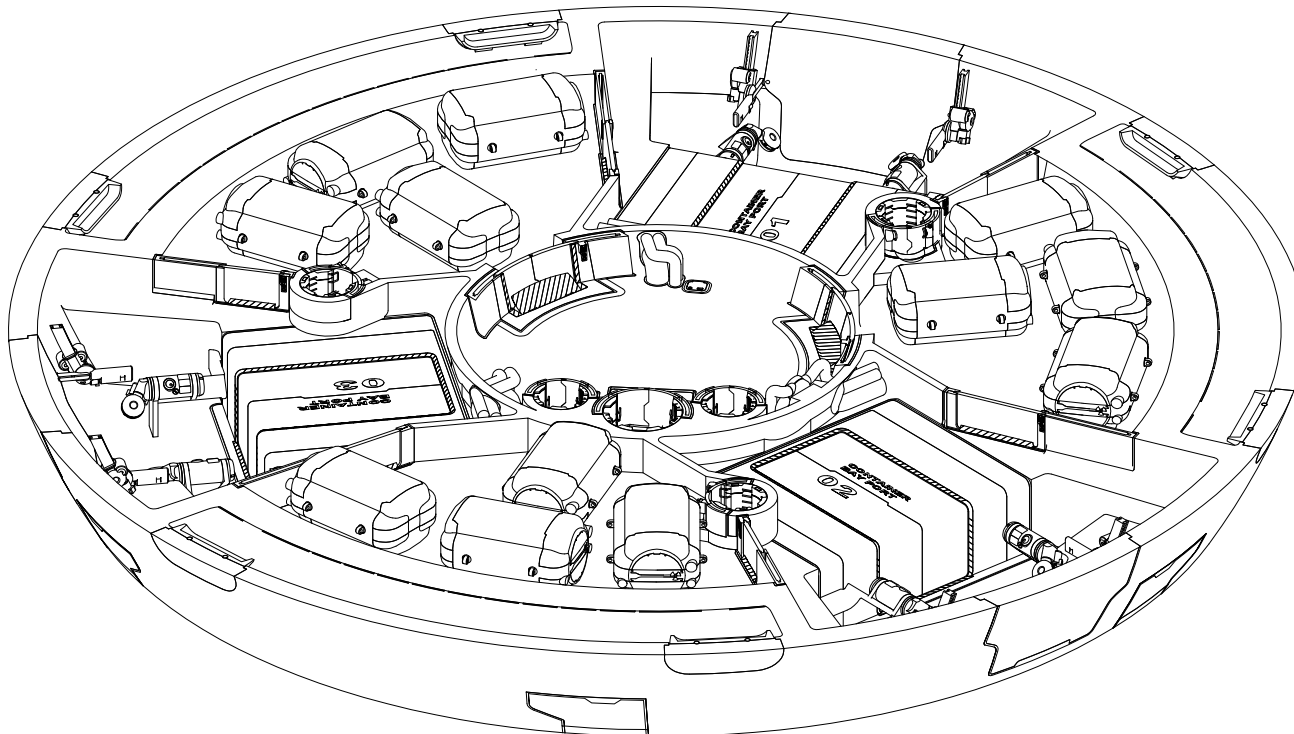

Korvettenprojekt 3435 A.D.

Schnittebene
- 9.820 m
- 15.500 m
230/30°

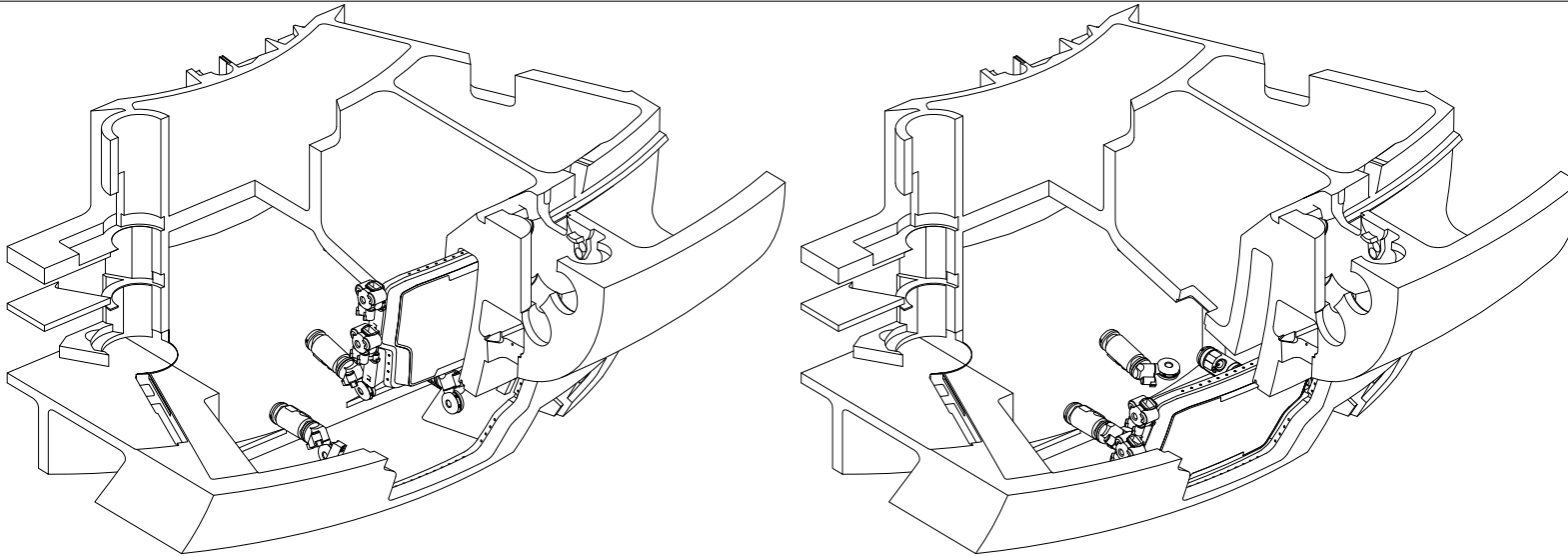
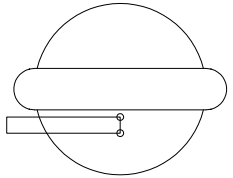

M 1:333

0 1 2 3 4 5m 

RECON

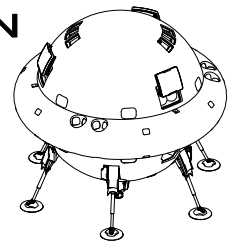

Blatt 009

<http://www.Korvettenprojekt.de>
(c) 2007 05.12 Holger Lagemann